

## FEATURES

- High Efficiency: Up to 96%
- 1.5MHz Constant Frequency Operation
- 800mA Output Current
- No Schottky Diode Required
- 2V to 6V Input Voltage Range
- Output Voltage as Low as 0.6V
- PFM Mode for High Efficiency in Light Load
- 100% Duty Cycle in Dropout Operation
- Low Quiescent Current: 20 $\mu$ A
- Slope Compensated Current Mode Control for Excellent Line and Load Transient Response
- Short Circuit Protection
- Thermal Fault Protection
- Inrush Current Limit and Soft Start
- <1 $\mu$ A Shutdown Current
- SOT23-5 package

## APPLICATIONS

- Cellular and Smart Phones
- Wireless and DSL Modems
- PDAs
- Portable Instruments
- Digital Still and Video Cameras
- DTV

## TYPICAL APPLICATION

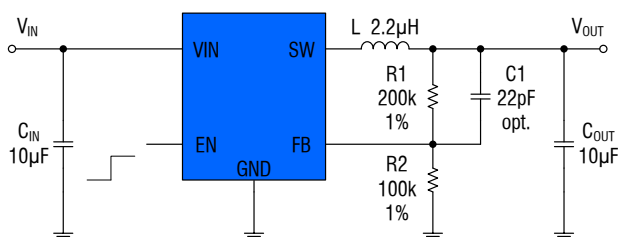
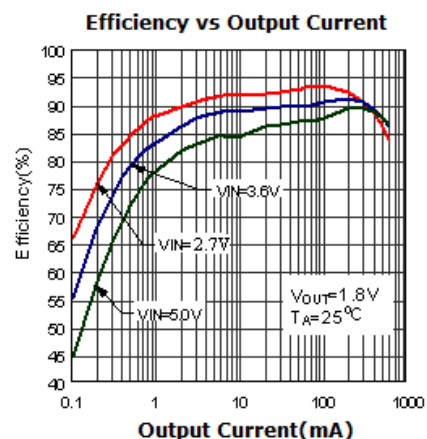

Figure 1. Basic Application Circuit

## GENERAL DESCRIPTION

The XR3406 is a constant frequency, current mode step-down converter. The device integrates a main switch and a synchronous rectifier for high efficiency without an external Schottky diode. It is ideal for powering portable equipment that runs from a single cell Lithium-Ion (Li+) battery. The output voltage can be regulated as low as 0.6V. The XR3406 can also run at 100% duty cycle for low dropout operation, extending battery life in portable system. This device offers two operation modes, PWM control and PFM Mode switching control, which allows a high efficiency over the wider range of the load.

The XR3406 is offered in a low profile 5pin, SOT package, and is available in an adjustable version.



## ABSOLUTE MAXIMUM RATINGS (Note 1)

Input Supply Voltage.....	-0.3V to 6.5V	Junction Temperature(Note2).....	150°C
EN,FB Voltages.....	-0.3V to ( $V_{IN} + 0.3V$ )	Operating Temperature Range.....	-40°C to 85°C
SW Voltage.....	-0.3V to ( $V_{IN} + 0.3V$ )	Lead Temperature(Soldering,10s).....	300°C
Power Dissipation.....	0.4W	Storage Temperature Range.....	-65°C to 150°C
Thermal Resistance $\theta_{JC}$ .....	130°C/W	ESD HBM(Human Body Mode).....	2kV
Thermal Resistance $\theta_{JA}$ .....	250°C/W	ESD MM(Machine Mode).....	200V

## PACKAGE/ORDER INFORMATION

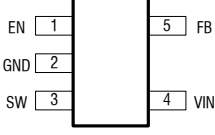
	Order Part Number	Package	Top Marking
<p style="text-align: center;">TOP VIEW</p>  <p style="text-align: center;">5-LEAD PLASTIC SOT-23  <math>T_{JMAX} = 150^{\circ}C</math>, <math>\theta_{JA} = 250^{\circ}C/W</math>, <math>\theta_{JC} = 130^{\circ}C/W</math></p>	XR3406	SOT23-5	A <u>XX</u> Y

## PIN DESCRIPTION

Pin Name	Pin Number	Description
EN	1	Chip Enable Pin. Drive EN above 1.5V to turn on the part. Drive EN below 0.3V to turn it off. Do not leave EN floating.
GND	2	Analog ground pin.
SW	3	Power Switch Output. It is the switch node connection to Inductor. This pin connects to the drains of the internal P-ch and N-ch MOSFET switches.
VIN	4	Power Supply Input. Must be closely decoupled to GND with a 4.7 $\mu$ F or greater ceramic capacitor.
FB	5	Output Voltage Feedback Pin. An internal resistive divider divides the output voltage down for comparison to the internal reference voltage.

**ELECTRICAL CHARACTERISTICS** (Note 3)

 ( $V_{IN}=V_{EN}=3.6V$ ,  $V_{OUT}=1.8V$ ,  $T_A = 25^{\circ}C$ , unless otherwise noted.)

PARAMETER	CONDITIONS	MIN	TYP	MAX	UNIT
Input Voltage Range		2		6	V
Input DC Supply Current	(Note 4)				$\mu A$
PWM Mode	$V_{OUT} = 90\%$ , $I_{LOAD} = 0mA$		140	300	$\mu A$
PFM Mode	$V_{OUT} = 105\%$ , $I_{LOAD} = 0mA$		20	35	$\mu A$
Shutdown Mode	$V_{EN} = 0V$ , $V_{IN} = 4.2V$		0.1	1.0	$\mu A$
Regulated Feedback Voltage $V_{FB}$	$T_A = 25^{\circ}C$	0.588	0.600	0.612	V
	$T_A = 0^{\circ}C \leq T_A \leq 85^{\circ}C$	0.586	0.600	0.613	V
	$T_A = -40^{\circ}C \leq T_A \leq 85^{\circ}C$	0.585	0.600	0.615	V
Reference Voltage Line Regulation	$V_{IN} = 2.7V$ to $5.5V$		0.04	0.40	%/V
Output Voltage Line Regulation	$V_{IN} = 2.7V$ to $5.5V$		0.04	0.40	%
Output Voltage Load Regulation			0.5		%
Oscillation Frequency	$V_{OUT} = 100\%$		1.5		MHz
	$V_{OUT} = 0V$		300		kHz
On Resistance of PMOS	$I_{SW} = 100mA$		300	450	m $\Omega$
On Resistance of NMOS	$I_{SW} = -100mA$		300	450	m $\Omega$
Peak Current Limit	$V_{IN} = 3V$ , $V_{OUT} = 90\%$		1.5		A
EN High-Level Input Voltage	$V_{ENH}$	1.5			V
EN Low-Level Input Voltage	$V_{ENL}$			0.4	V
EN Leakage Current			$\pm 0.01$	$\pm 1.0$	$\mu A$
SW Leakage Current	$V_{EN} = 0V$ , $V_{IN} = V_{SW} = 5V$		$\pm 0.01$	$\pm 1.0$	$\mu A$

**Note 1:** Absolute Maximum Ratings are those values beyond which the life of a device may be impaired.

**Note 2:**  $T_j$  is calculated from the ambient temperature  $T_A$  and power dissipation  $P_D$  according to the following formula:  $T_j = T_A + (P_D) \times (25^{\circ}C/W)$ .

**Note 3:** 100% production test at  $+25^{\circ}C$ . Specifications over the temperature range are guaranteed by design and characterization.

**Note 4:** Dynamic supply current is higher due to the gate charge being delivered at the switching frequency.

## TYPICAL PERFORMANCE CHARACTERISTICS

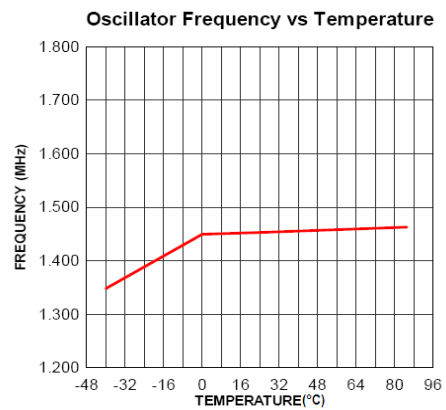
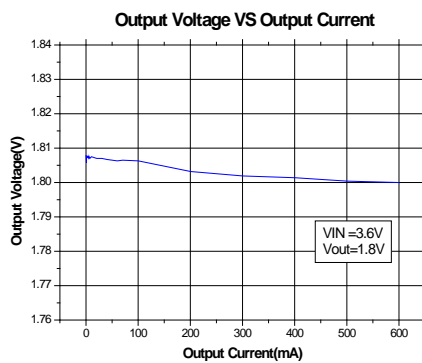
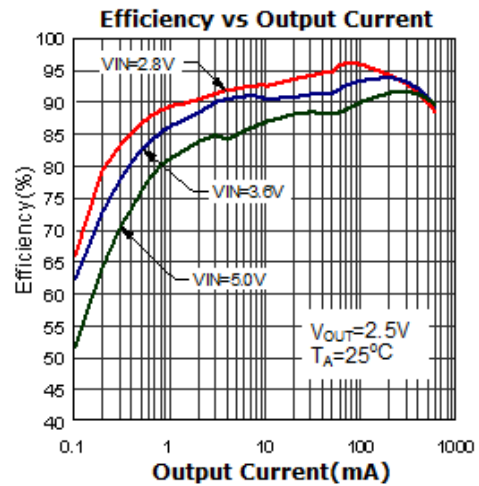
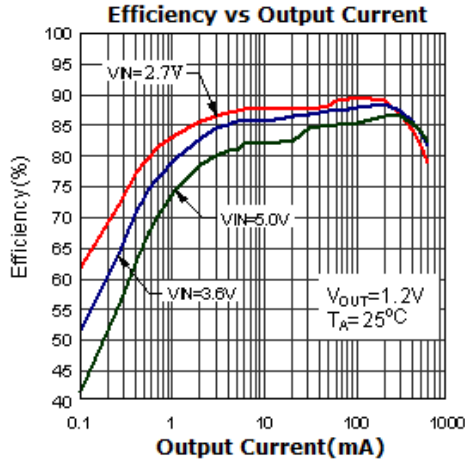

PFM MODE

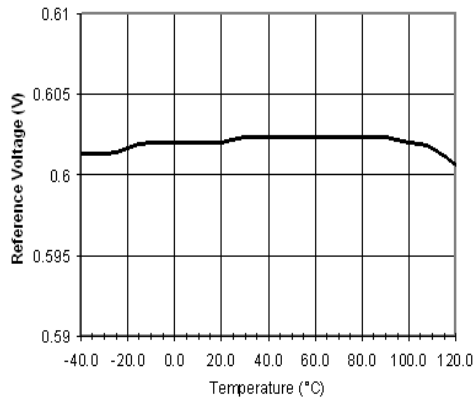

PWM MODE

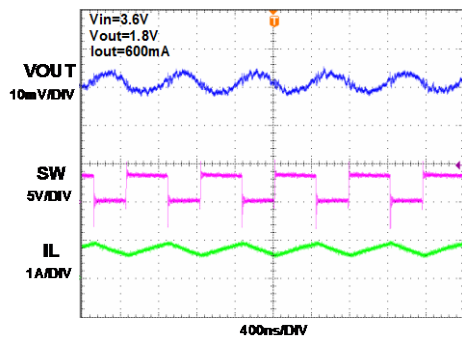

START UP RESPONSE

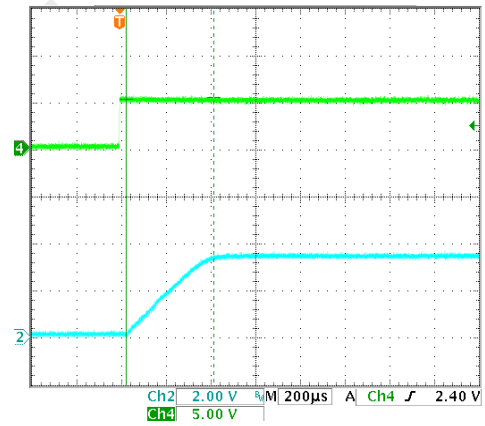

## FUNCTIONAL BLOCK DIAGRAM

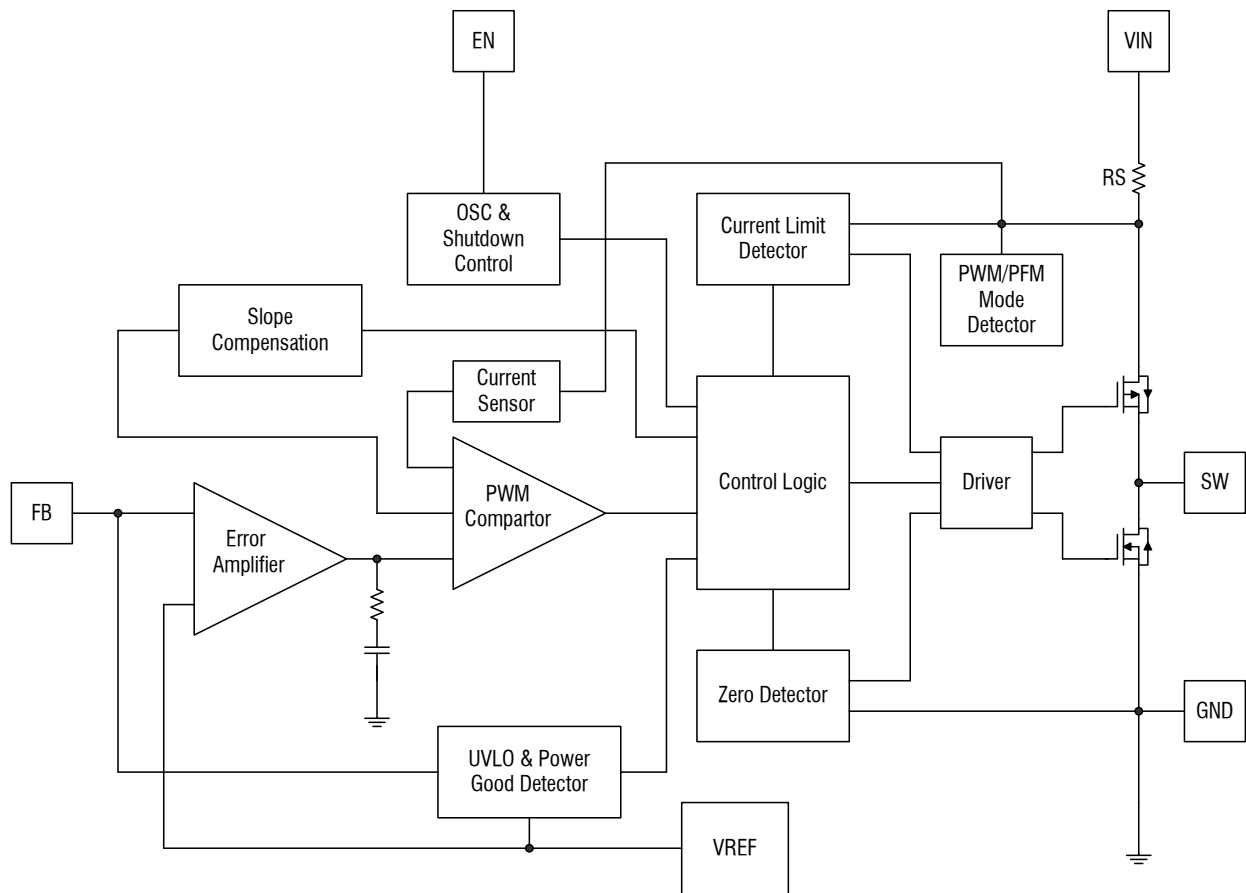

Figure 2. XR3406Block Diagram

## FUNCTIONAL DESCRIPTION

The XR3406 is a high performance, 800mA, 1.5MHz monolithic step-down converter. The XR3406 requires only three external power components ( $C_{IN}$ ,  $C_{OUT}$  and L). The adjustable version can be programmed with external feedback to any voltage, ranging from 0.6V to the input voltage.

At dropout operation, the converter duty cycle increases to 100% and the output voltage tracks

the input voltage minus the  $R_{DS(ON)}$  drop of the high-side MOSFET.

The internal error amplifier and compensation provides excellent transient response, load, and line regulation. Soft start function prevents input inrush current and output overshoot during start up.

## APPLICATIONS INFORMATION

### Setting the Output Voltage

The internal reference  $V_{REF}$  is 0.6V (Typical). The output voltage is divided by a resistor, R1 and R2 to the FB pin. The output voltage is given by:

$$V_{OUT} = 0.6 \times \left( 1 + \frac{R1}{R2} \right)$$

### Inductor Selection

For most designs, the XR3406 operates with inductors of  $1\mu\text{H}$  to  $4.7\mu\text{H}$ . Low inductance values are physically smaller but require faster switching, which results in some efficiency loss. The inductor value can be derived from the following equation:

$$L = \frac{V_{OUT} \times (V_{IN} - V_{OUT})}{V_{IN} \times \Delta I_L \times f_{OSC}}$$

Where  $\Delta I_L$  is inductor Ripple Current. Large value inductors result in lower ripple current and small value inductors result in high ripple current. For optimum voltage-positioning load transients, choose an inductor with DC series resistance in the  $50\text{m}\Omega$  to  $150\text{m}\Omega$  range.

### Input Capacitor Selection

The input capacitor reduces the surge current drawn from the input and switching noise from the device. The input capacitor impedance at the switching frequency should be less than input source impedance to prevent high frequency switching current passing to the input. A low ESR input capacitor sized for maximum RMS current must be used. Ceramic capacitors with X5R or X7R dielectrics are highly recommended because of their low ESR and small temperature coefficients. A  $4.7\mu\text{F}$  ceramic capacitor for most applications is sufficient. A large value may be used for improved input voltage filtering.

### Output Capacitor Selection

The output capacitor is required to keep the output voltage ripple small and to ensure regulation loop stability. The output capacitor must have low impedance at the switching frequency. Ceramic capacitors with X5R or X7R dielectrics are recommended due to their low ESR and high ripple current ratings. The output ripple  $\Delta V_{OUT}$  is determined by:

$$\Delta V_{OUT} \leq \frac{V_{OUT} \times (V_{IN} - V_{OUT})}{V_{IN} \times f_{OSC} \times L} \times \left( \text{ESR} + \frac{1}{8 \times f_{OSC} \times C_{OUT}} \right)$$

A  $10\mu\text{F}$  ceramic can satisfy most applications.

### PCB Layout Recommendations

When laying out the printed circuit board, the following checking should be used to ensure proper operation of the XR3406 Check the following in your layout:

- The power traces, consisting of the GND trace, the SW trace and the VIN trace should be kept short, direct and wide
- Does the (+) plates of  $C_{IN}$  connect to VIN as closely as possible. This capacitor provides the AC current to the internal power MOSFETs.
- Keep the switching node, SW, away from the sensitive  $V_{OUT}$  node.
- Keep the (-) plates of  $C_{IN}$  and  $C_{OUT}$  as close as possible

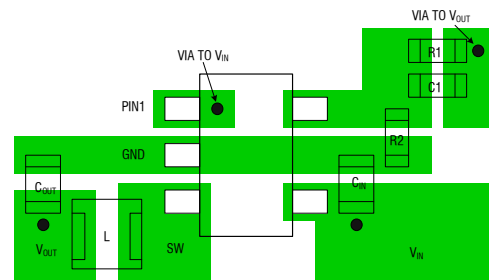
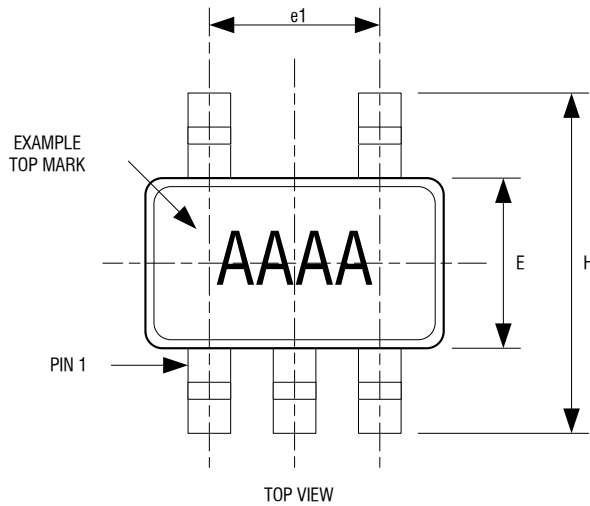

Figure 3. XR3406Suggested Layout

## PACKAGE DESCRIPTION

### SOT23-5



5LD SOT-23 PACKAGE OUTLINE DIMENSIONS

Dimension	Min.	Max.
A	1.05	1.35
A1	0.04	0.15
B	0.3	0.5
C	0.09	0.2
D	2.8	3.0
H	2.5	3.1
E	1.5	1.7
e	0.95 REF.	
e1	1.90 REF.	
L1	0.2	0.55
L	0.35	0.8
Q	0°	10°

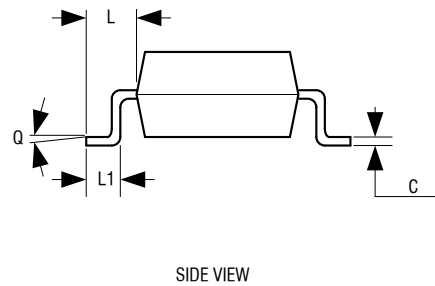
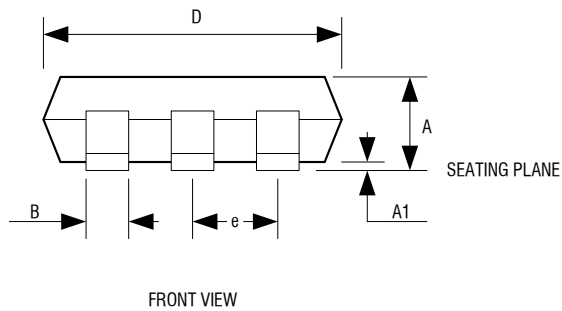

- NOTE:
- 1.DIMENSIONS ARE IN MILLIMETERS
  - 2.DRAWING NOT TO SCALE
  - 3.DIMENSIONS ARE INCLUSIVE OF PLATING
  - 4.DIMENSIONS ARE EXCLUSIVE OF MOLD FLASH AND METAL BURR